

This is a zoom lens for mounting onto a DLP™ projector. The focal length can be changed to enable various projection distances.

NOTE: The lens cannot be used by itself. It must be mounted onto the specified Panasonic DLP™ projector.

Specifications

F value:	1.8–2.4
Focal distance (f):	33.9 mm–53.2 mm
Dimensions (W x H x D):	95 x 95 x 168 mm (3-3/4" x 3-3/4" x 6-5/8")
Weight:	1.0 kg (2.2 lbs)

Dimensions

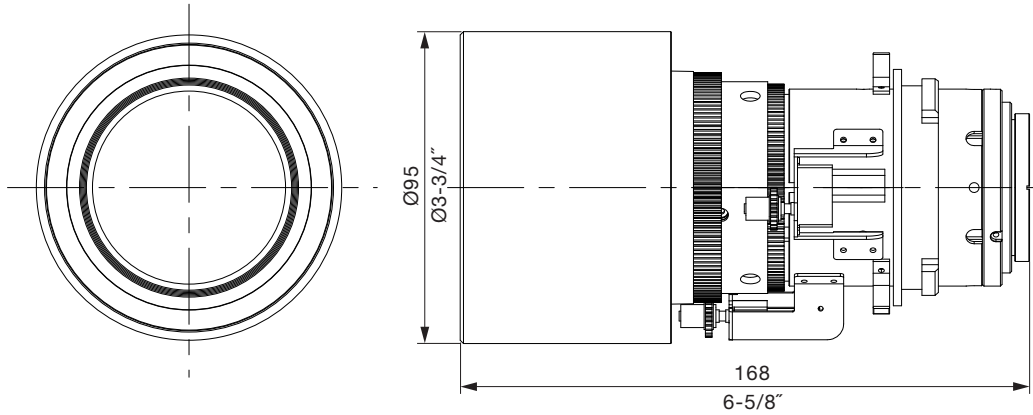
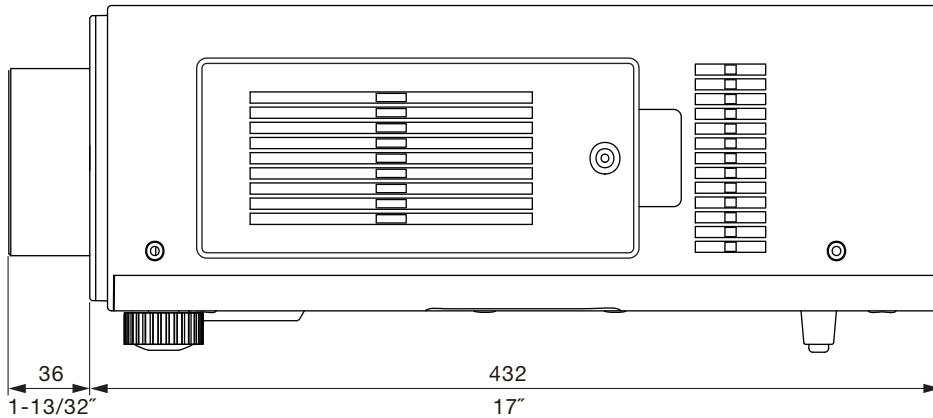
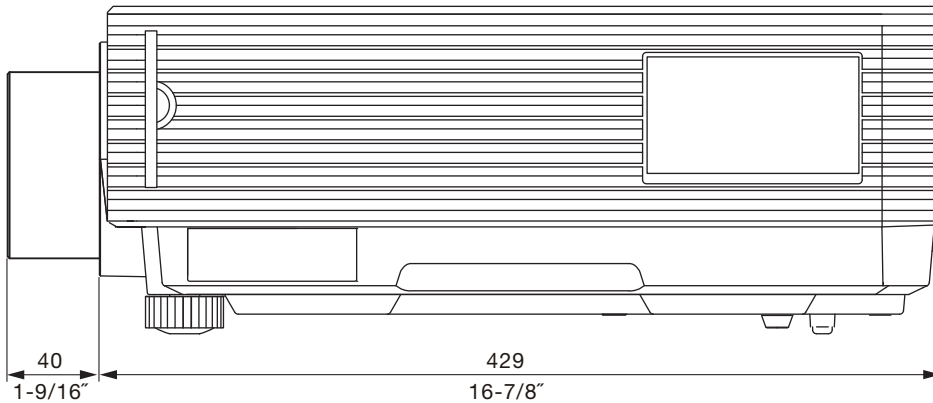

Illustration shows the lens attached to the PT-DZ6710/DZ6710/DZ6700/DZ6700L/DW6300S/DW6300LS/DW6300K/DW6300LK/D6000S/D6000LS/D6000K/D6000LK.



The illustration shows the lens attached to the PT-D4000.



unit : mm (inch)

NOTE: This illustration is not drawn to scale.

For information on the projection distance, refer to the specifications for the projector to which the lens will be mounted. DLP is a trademark of Texas Instruments. Weights and dimensions shown are approximate. Specifications subject to change without notice.